



BTR-60P APC

eduard

36 186

1/35 scale detail set for Trumpeter kit 01542 • sada detailů pro model 1/35 Trumpeter 01542

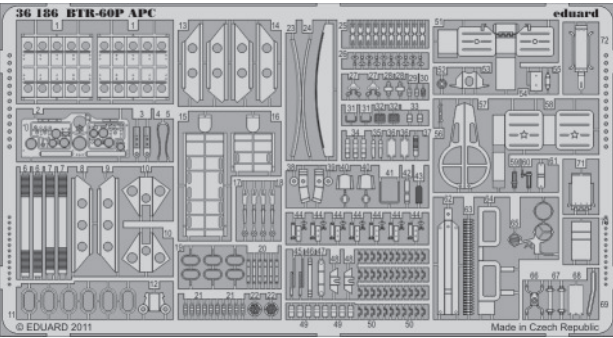

- ★ APPLY EXPRESS MASK AND PAINT BEFORE GLUING
POUŽIT EXPRESS MASK NABARVIT PŘED SLEPENÍM
- ☉ SYMMETRICAL ASSEMBLY
SYMETRICKÁ MONTÁŽ
- REMOVE
ODSTRANIT
- ▨ GRIND
OBROUSIT
- ⊘ DRILL HOLE
VRTAT OTVOR
- ↪ BEND
OHNOUT
- ⊕ OPTION
VOLBA
- Ⓜ REPLACE
NAHRADIT

ORIGINAL KIT PARTS
PŮVODNÍ DÍLY STAVEBNICE
 PHOTO-ETCHED PARTS
LEPTANÉ DÍLY
 PARTS TO BE REMOVED
DÍLY K ODSTRANĚNÍ
 FILL
TMELIT

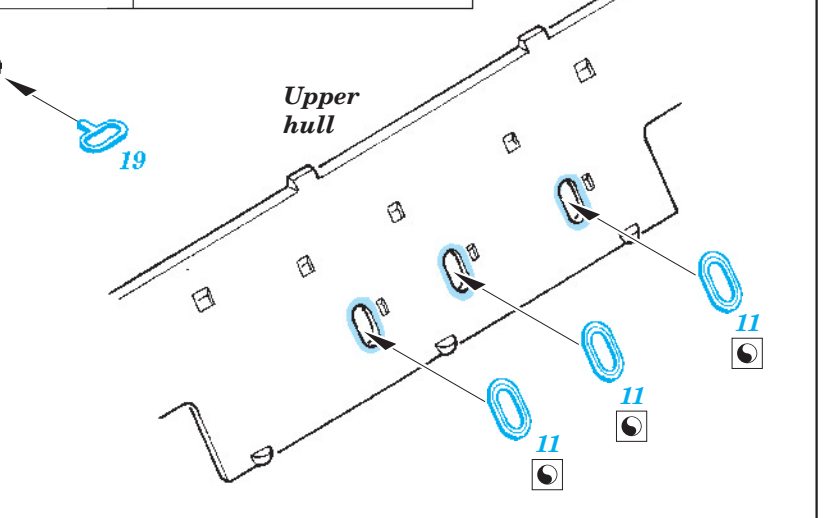
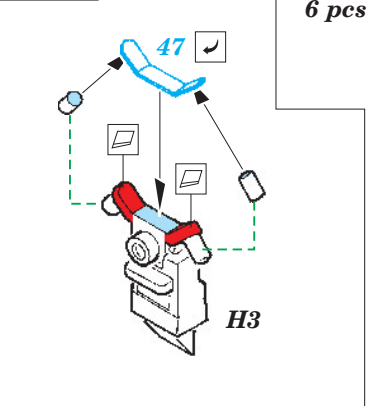
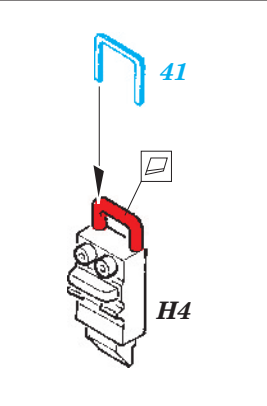
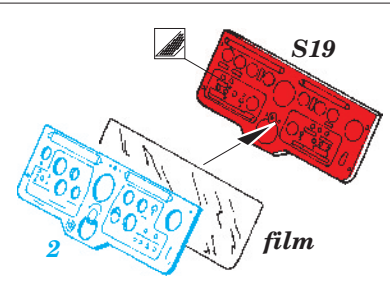
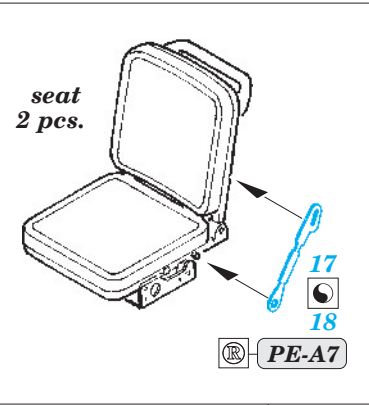
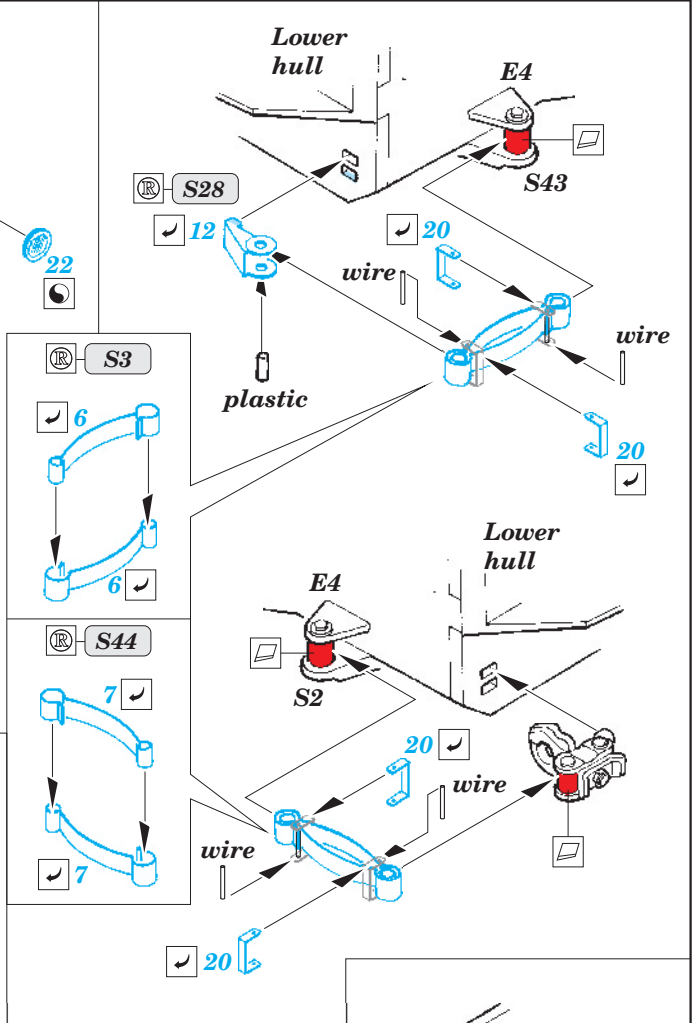
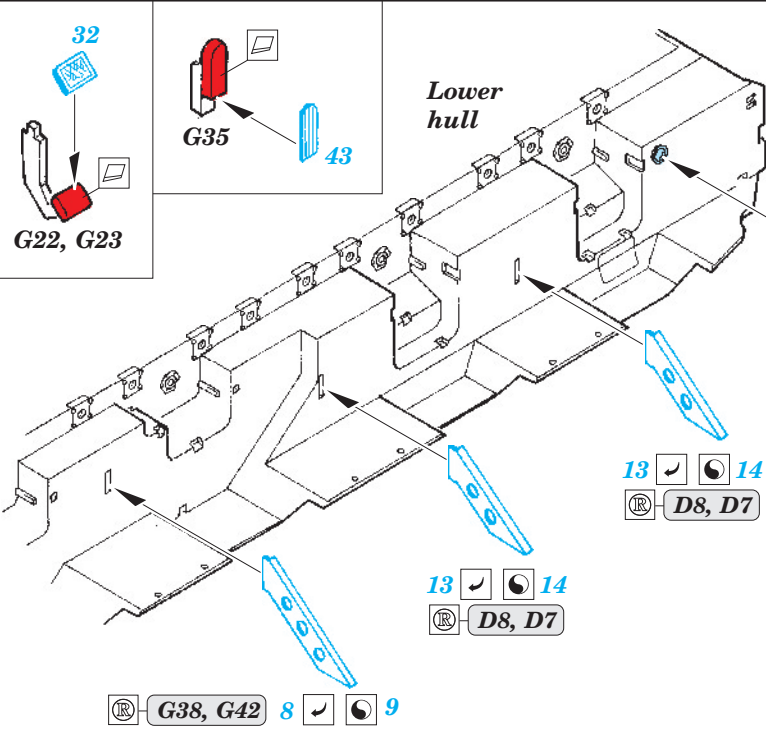

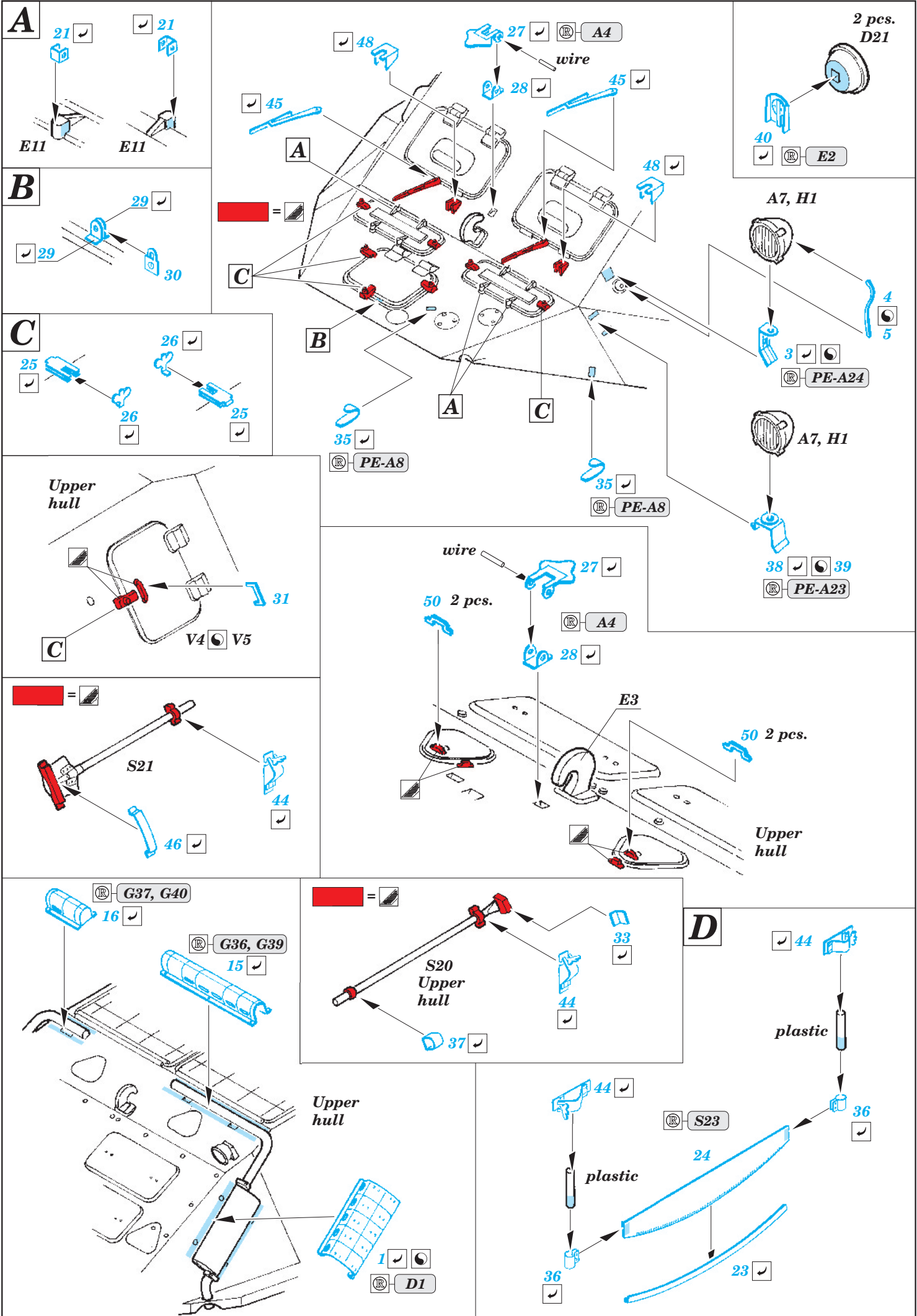

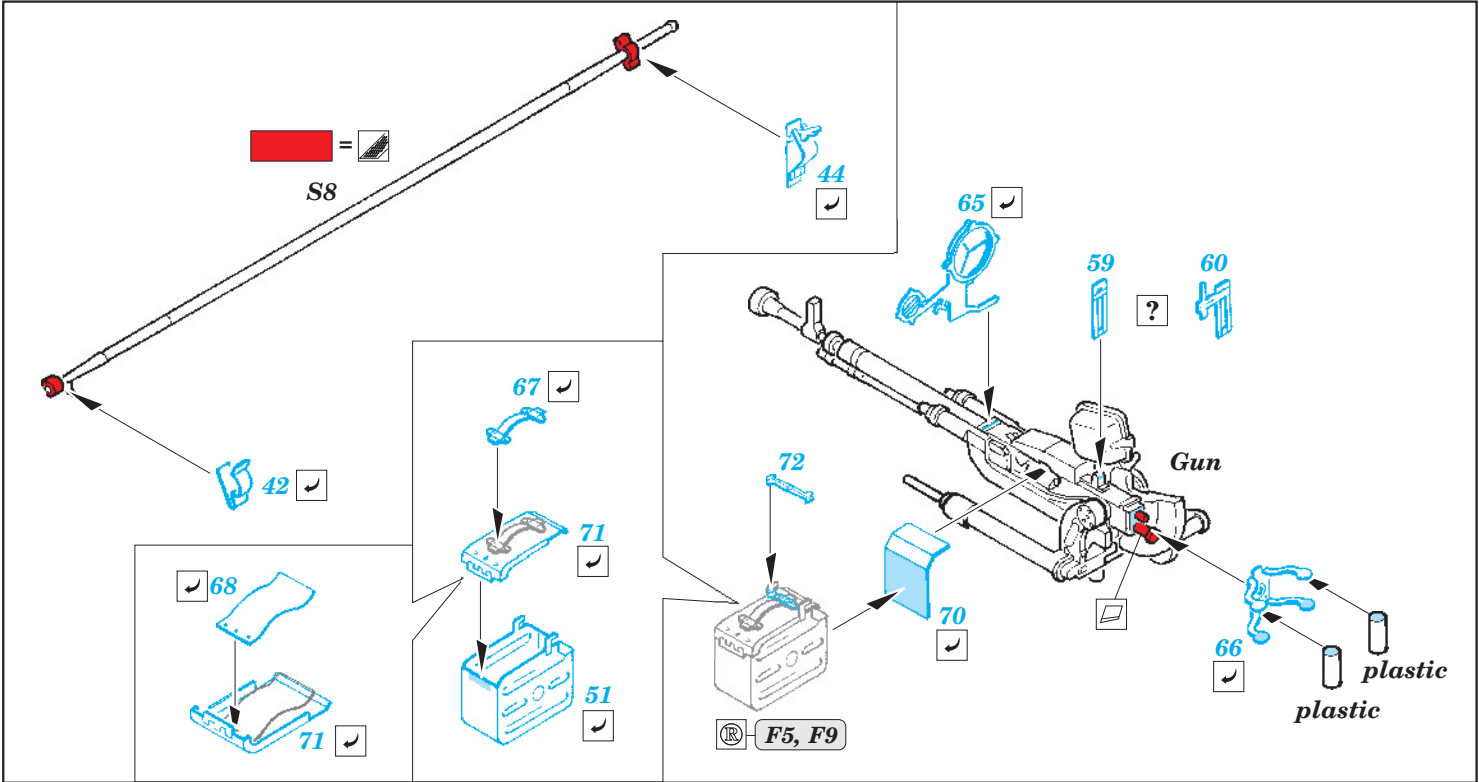

HOW TO MAKE THE RELIEF ON OPPOSITE - REVERSE - OF THE PLATE

