

A-7E 156831 VA-146 CVW-9 "BLUE DIAMONDS" USS CONSTELLATION
 MARCH 1979 LT. GENE PACE

72-420

GENERAL PAINTING INFORMATION

LIGHT GULL GRAY- ALL UPPER SURFACES OF FUSELAGE, WING AND TAIL.
 EXCEPT RUDDER, FLAPS AND STABILATORS.

WHITE- ALL UNDER SURFACES OF FUSELAGE AND WINGS, RUDDER,
 FIN TIP, AILERONS, FLAPS, STABILATORS, WHEEL WELLS, GEAR
 STRUTS, MISSILES AND AUX. FUEL TANKS.

BLACK- ANTI GLARE PANEL

BARE METAL- LEADING EDGES OF STABILATOR.

NATIONAL INSIGNIAS- WINGS UPPER PORT AND LOWER STARBOARD 35"
 FUSELAGE 30"

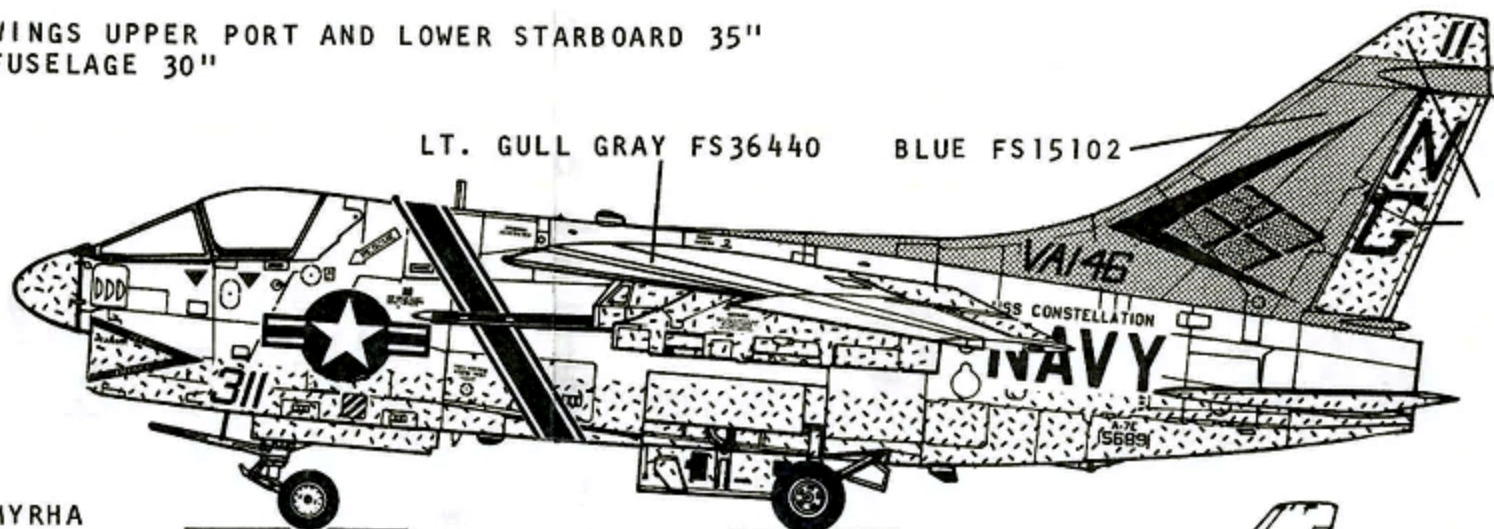
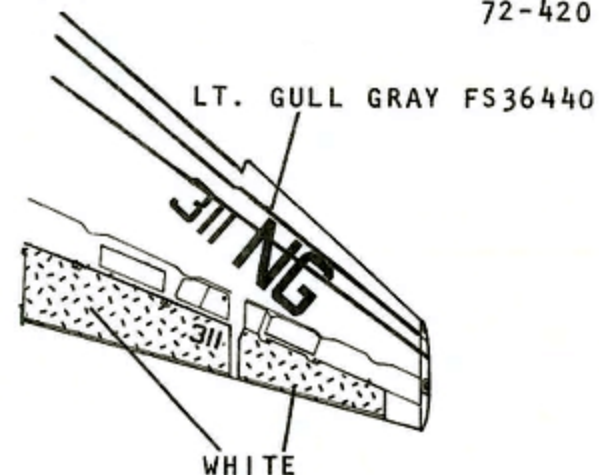

RESEARCH BY
 DON GARRETT AND KEN MYRHA

STANDARD A-7 DATA

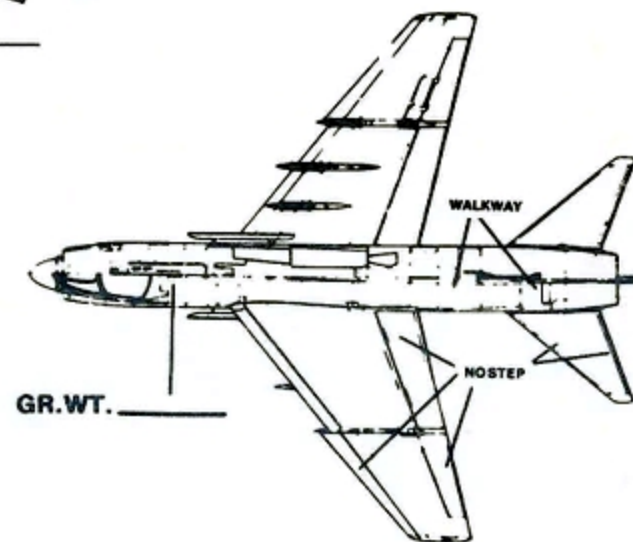
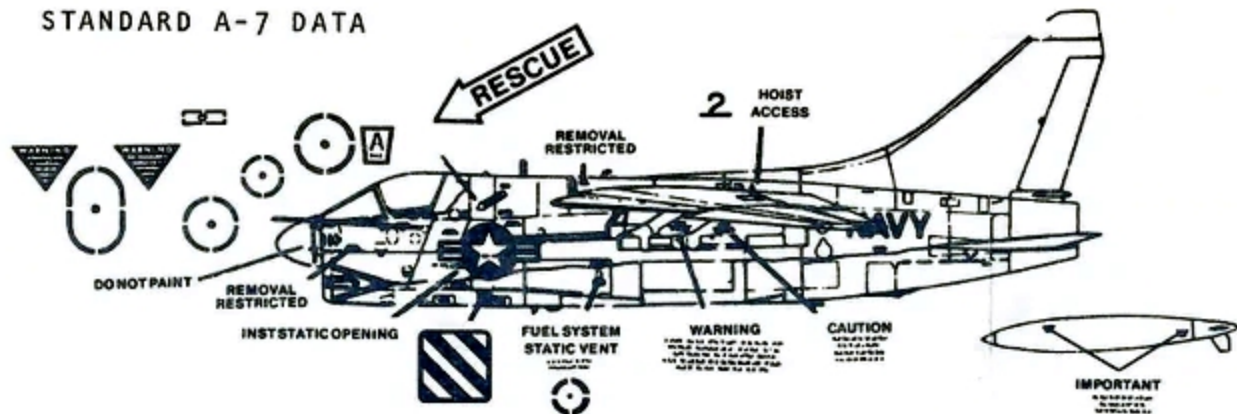

F-4B 151409 VF-92 CVW-9 8/1964 TO 5/1965
 U.S.S. RANGER CVA-61 "SILVERKINGS"

GENERAL PAINTING INFORMATION

LIGHT GULL GRAY- ALL UPPER SURFACES OF FUSELAGE, WINGS AND TAIL.

WHITE- ALL UNDER SURFACES OF FUSELAGE, AND WINGS. RUDDER AILERONNS
 OUTER PORTION OF STABILIZERS, WHEEL WELLS, GEAR STRUTS, MISSLES,
 AND AUX. FUEL TANKS.

BARE METAL- LEADING EDGES OF ALL FLYING SURFACES AND INTAKES, INNER
 PORTION OF STABILATORS AND TAIL AREAS

BLACK- ANTI GLARE PANEL AND RADOME

DARKENED BARE METAL- EXHAUST CONES AND BLAST AREAS

NATIONAL INSIGNIAS- UPPER PORT AND LOWER STARBOARD WINGS 45"
 FUSELAGE 30"

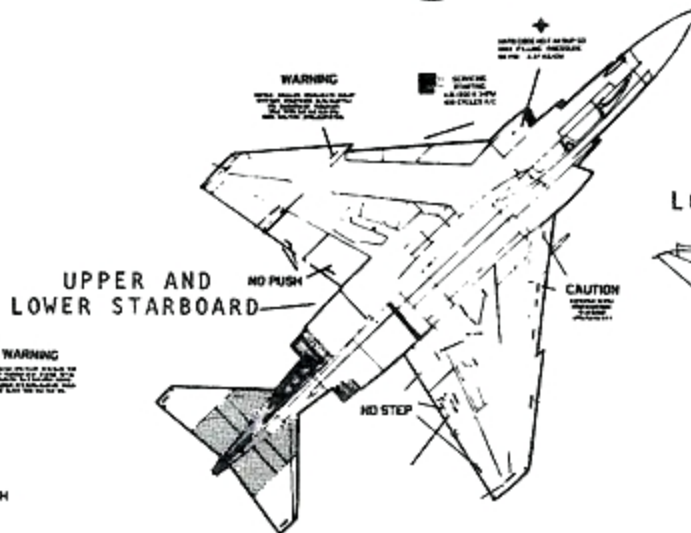
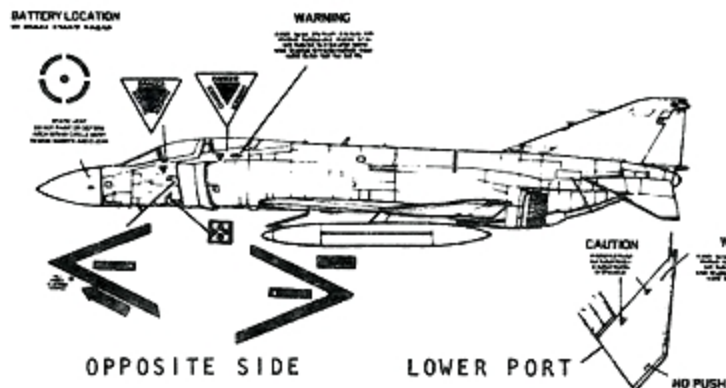
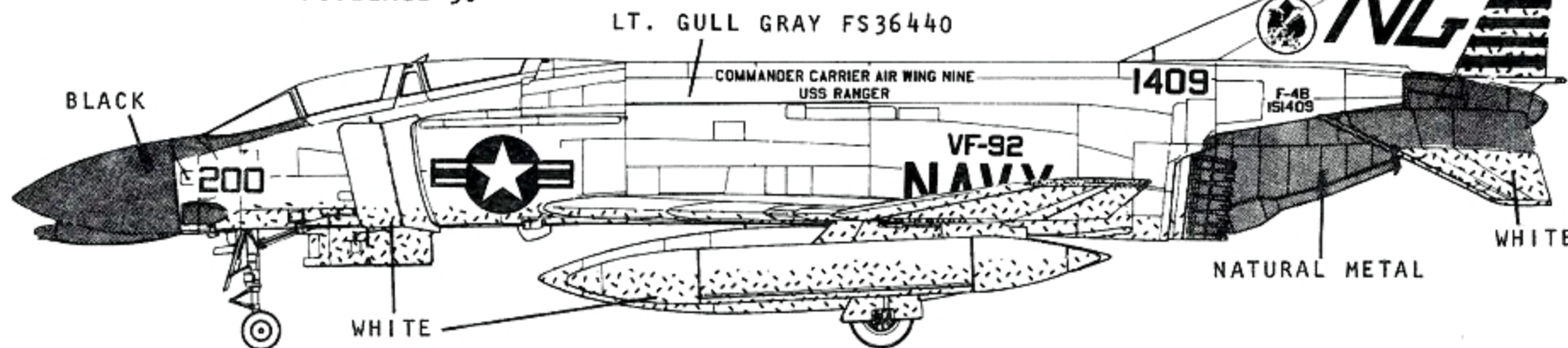
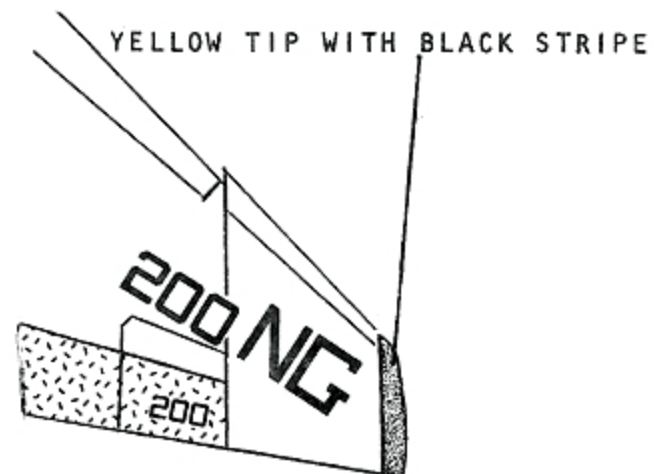

LOWER STARBOARD

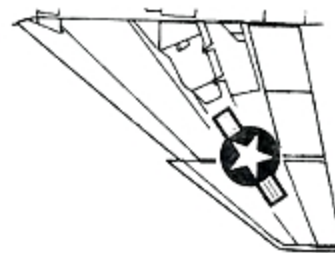

UPPER PORT

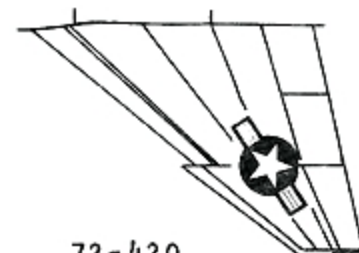

72-420