

**eduard**  
**Express Mask**

**XS 562**

# Ju-88/188

## Night Fight. Nat. Insignia

A die-cut mask for accurate painting of markings

FOR 1/72 KIT

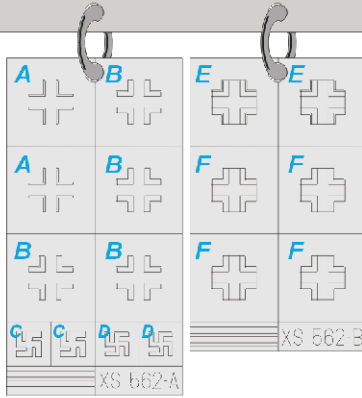

**1. A;B**

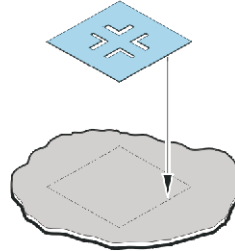

**2.**

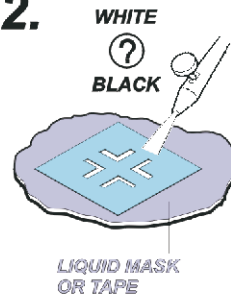

**3.**

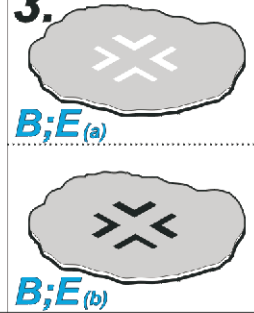

**1. C+D**

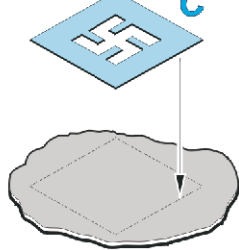

**2.**

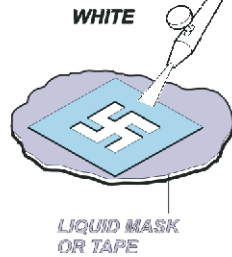

**3.**

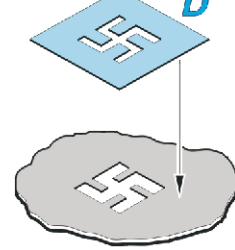

**4.**

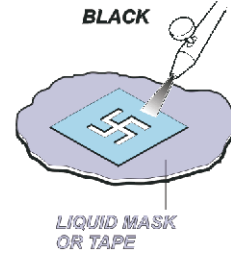

**5.**



**1. E**

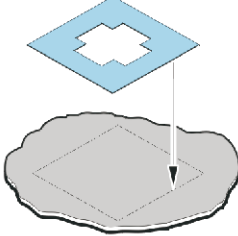

**2.**

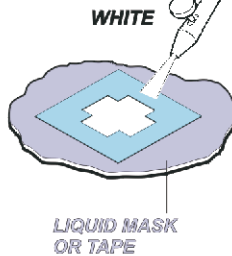

**3.**

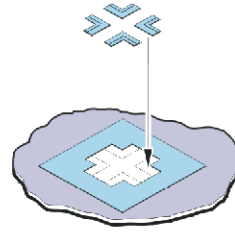

**4.**

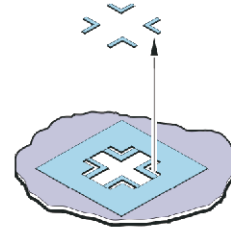

**5.**

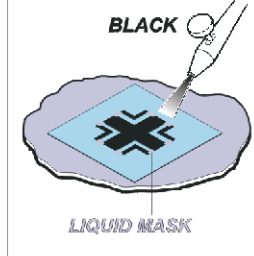

**6.**



**1. D**

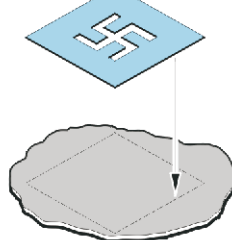

**2.**

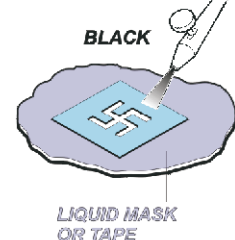

**3.**



**1. F**

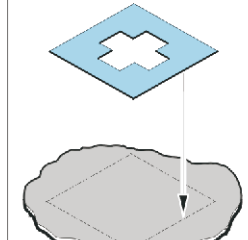

**2.**

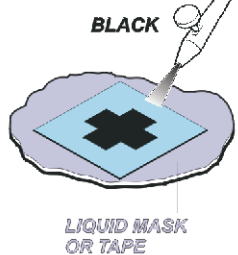

**3.**

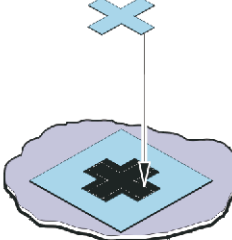

**4.**

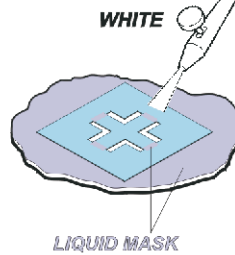

**5.**



### SCHEMA 1)

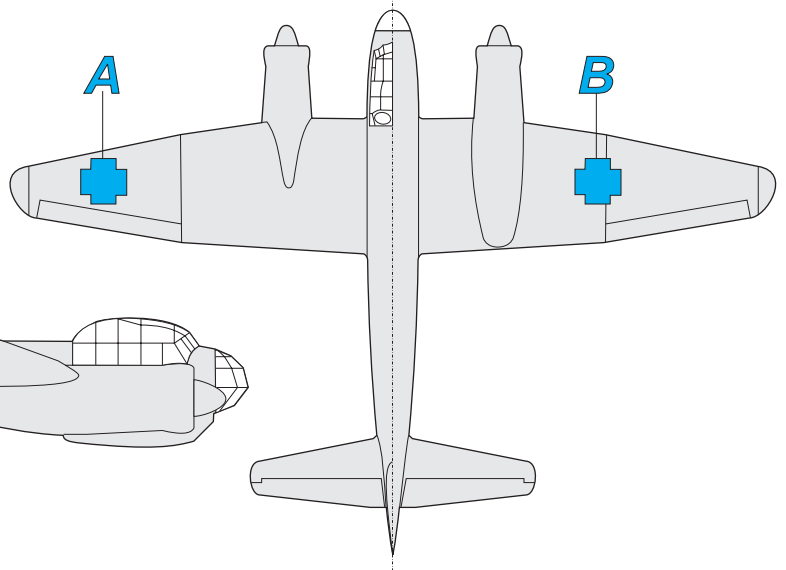
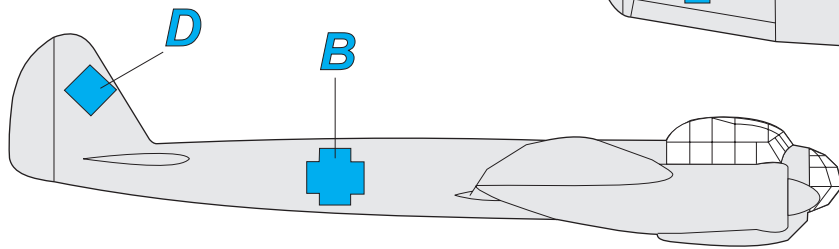

### SCHEMA 2)

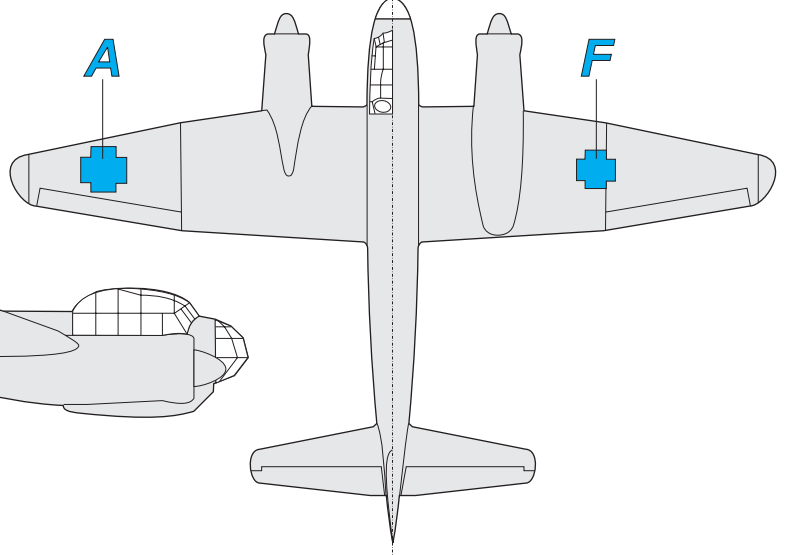
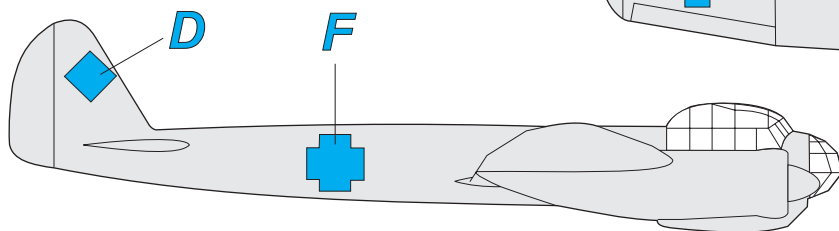

### SCHEMA 3)

